

**G. Rebel<sup>1</sup>, R. Verreet<sup>2</sup> and I.M.L. Ridge<sup>1</sup>**

ODN 0770

<sup>(1)</sup>CASAR Drahtseilwerk Saar GmbH, Kirkel, Germany,<sup>(2)</sup>Wire Rope Technology Aachen, Aachen, Germany

## Lightweight ropes for lifting applications

### Summary

The level of wire rope technology used in lifting or hoisting applications has a significant effect on the overall efficiency of the system. This paper presents various examples which show the different benefits which may be accrued from the use of lightweight ropes.

Most hoisting operations by their very nature involve long lengths of rope in the system. In the deep mining application, these lengths may easily be 3000 m or more. At this length the rope self weight becomes a significant component of the total payload which it has to support. A 20% reduction in the rope mass per metre for a typical hoist rope (of the same strength) will allow an increase in the skip payload of 30% at 3000 m.

In the case of a crane, the weight of the rope can form a large part of the whole machine. Here, reduction in rope weight can allow benefits in terms of stability and in the case of mobile cranes, significant savings in axle loads. Another area where composite ropes may provide advantages is in the offshore environment where the lightweight benefits of fibre may be combined with the ruggedness of steel wire.

The paper closes by making a brief discussion of the issues of NDT inspection of such ropes.

### 1 Introduction and literature review

This paper is concerned with the concept of composite ropes for lifting applications. The term "composite" is taken to mean a rope which is a steel and fibre combination rope where the fibre in the rope is an integral load bearing member. The types of fibre under consideration are either of an aramid type (e.g. trade name Kevlar<sup>®</sup>) or high modulus polyethylene (e.g. Spectra<sup>®</sup> and Dynema<sup>®</sup>) which have very high breaking strengths associated with low stretch and low densities (compared to steel).

The idea of combining high strength fibres with steel wires in a rope construction is not new. In 1977 a UK patent (GB1578858) was filed entitled "*Wire-rope with load-carrying core fibres*" which described a steel wire rope incorporating a core of aromatic polyamide fibres which act as load-carrying elements and are lubricated. Several years later Klees *et al.* (1989) described a composite steel wire rope in their US patent which is exactly the configuration discussed here, but with some minor modifications. Figure 1 shows the cross-section of the Klees *et al.* rope structure which includes a jacketed Kevlar<sup>®</sup> core.

The rope was described by Klees *et al.* as "A composite wire rope comprising a plurality of outer strands laid helically about a helically stranded core. The core is comprised of high strength synthetics, such as polyamide or polyolefin materials to form a unitized lay central member. The method for forming the rope comprises the

steps of twisting high strength synthetic monofilament yarns into core elements to provide a high degree of stability and overall tensile strength. Each such element is helically laid in a single operation to form the finished core. Lubricant may be applied and subsequently a protective jacket of steel, natural or synthetic material may be provided to encapsulate the core and lubricant. The rope structure is completed by helically laying a plurality of outer strands about the core."

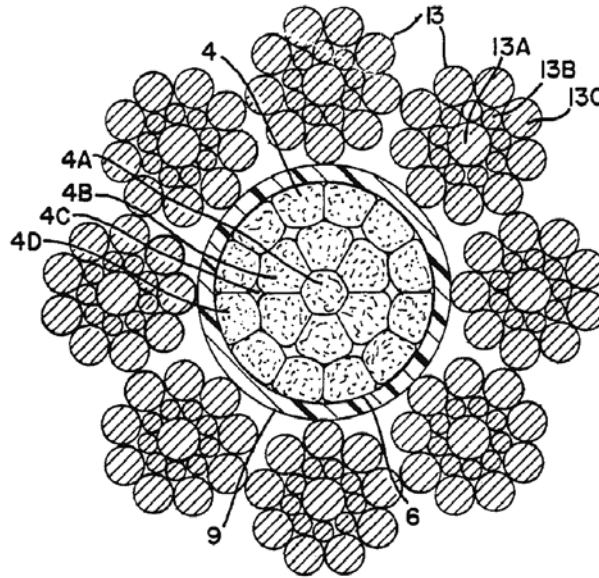

**Figure 1:** Composite steel wire rope as proposed by Klees et al. (1989) in their US patent filed in September 1988. 4 - Kevlar<sup>®</sup> core and core elements, 6 - Lang's lay coated fibre core, 9 - Core protective coating, 13 - Steel outer strands.

An extension of the composite rope theme is the tapered mass rope proposed by McKenzie (1990) with the application of deep mine hoisting in mind. The tapered mass rope involves progressively removing steel from the rope to reduce its mass (and breaking strength) while maintaining the overall rope diameter, Figure 2. The motivation for this design is that in deep vertical shafts less rope strength is required at the conveyance than at the head sheave as a result of the suspended rope mass. In theory a rope could be constructed that would have varying metallic cross-section and where the wires in the strands are progressively replaced by polymer fibres or rods. Unfortunately the practical problems of manufacturing such a rope and ensuring its integrity during operation have prevented one ever being manufactured. It would appear that in general a composite rope, like that proposed by Klees et al. and others, is a more realistic solution for a composite rope.

More recently authors such as Dolan (2003) have discussed how high strength carbon fibres can be used to enhance the properties of wire ropes in applications where special mechanical properties are needed that are not provided by steel-only constructions. There is also a substantial body of literature which deals with the application of high strength fibre ropes (i.e. fibre only) in various applications such as elevator systems and offshore mooring. Examples include the book by McKenna *et al.* (2004) which gives a broad description of the design and application of fibre ropes and Olsen and O'Donnell (1999) where the use and magnetic inspection of Kevlar<sup>®</sup> elevator ropes is described.

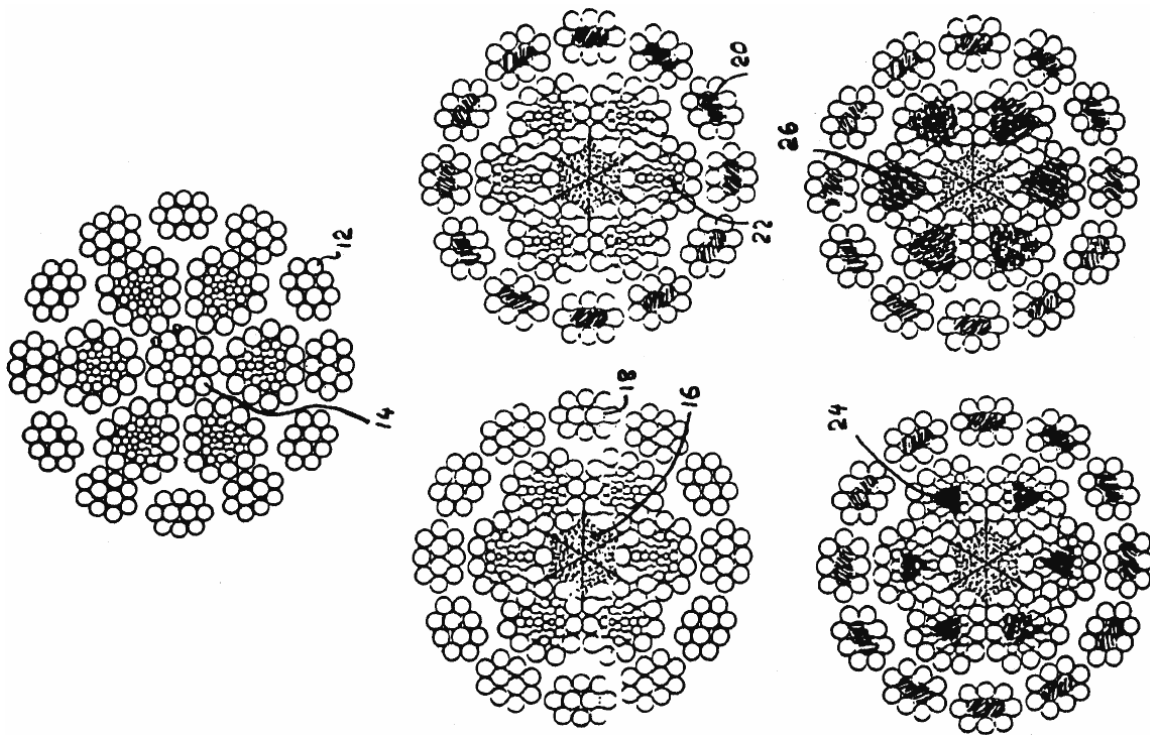

**Figure 2:** Reduced or tapered mass rope as proposed by McKenzie (1990) for deep shaft mine hoisting applications. The five cross-sections show progressive replacement of steel with polymer material moving down the shaft. 12 - Fishback wire strand, 14 - Steel wire rope core, 16 - Synthetic fibre rope core, 18 - Outer steel wires, 20 - Synthetic fibre strand core, 22 - Steel wire strand core (triangular), 24 - Synthetic strand core (triangular), 26 - Extended synthetic strand core (triangular).

However, for lifting applications it is unlikely that fibre-only ropes will be robust enough to withstand handling during installation and maintenance operations. Deterioration on multi-layer drums will also be a limiting factor. The solution to the problem would seem to lie between the two - composite steel and fibre ropes which would combine the robustness of a steel rope with the weight saving properties of fibre ropes.

This paper suggests various applications for this technology. The first is a discussion of the use of composite ropes in the deep mine hoisting application. An example is made of a design based on a typical hoist rope. Here the benefits of a composite rope can be very readily appreciated, as there is a direct correlation between the reduced mass of the suspended rope length and increase in paying payload. A second example presented here is the application of a mobile crane. In this case the benefits are not so directly obvious, but are none the less, very real. Thirdly, the use of composite ropes in offshore applications is considered, where deepwater challenges make this type of rope an attractive proposition.

The paper closes by making a brief examination of issues related to the effective non-destructive testing of composite ropes.

## 2 Mine hoisting: rope weight reduction and strength increase on shaft output

The level of wire rope technology used in mining applications can have a significant effect on the overall efficiency of the hoisting system. In this section, examples are given of the effects which reductions in rope mass per unit length and increases in rope breaking strength can have on rock skip capacity.

Figure 3 shows a typical configuration of a drum winder for hoisting rock in a vertical shaft. Considering first the standard rope constructions used for these applications, it is clear that any increase in the strength to mass ratio of the ropes would have a positive effect on the efficiency of the winder and on shaft output capacity.

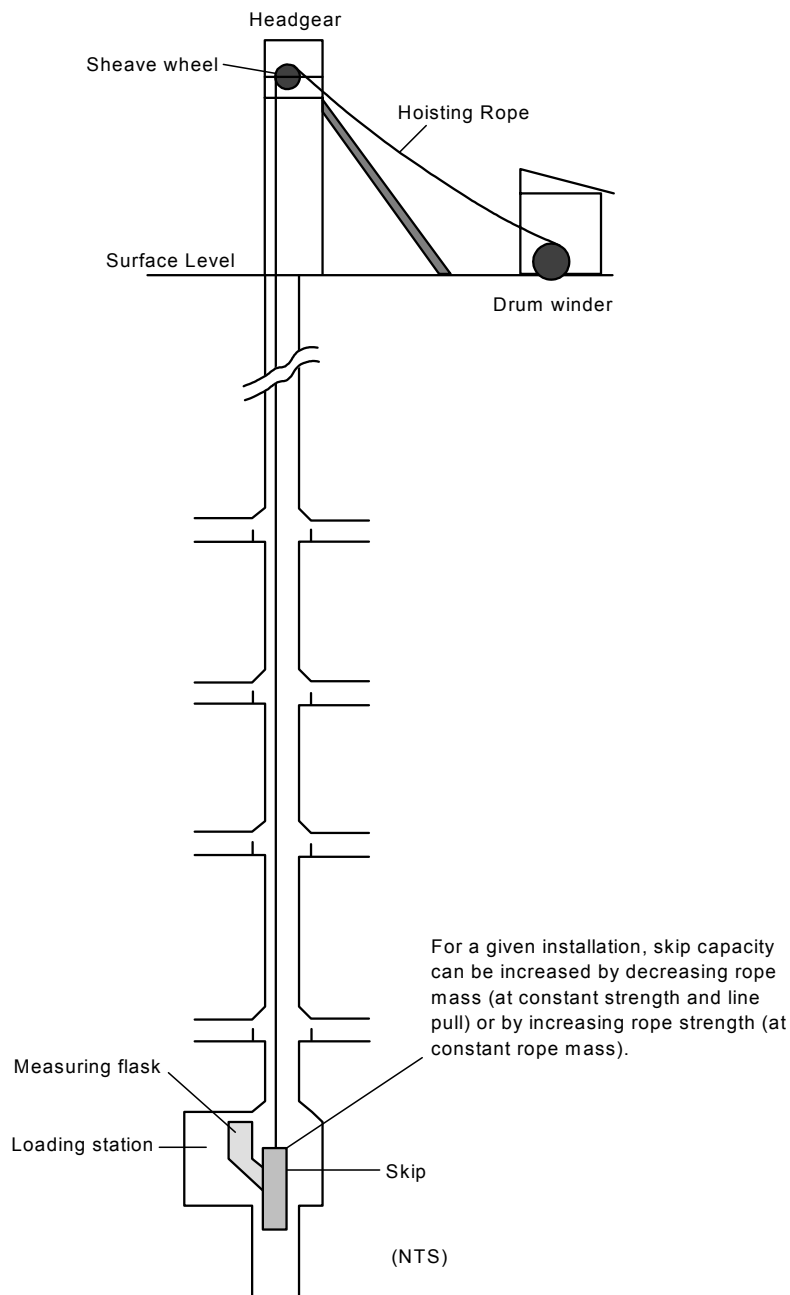

**Figure 3:** Typical vertical shaft rock winder configuration. Current shaft depths range from a few 100 m to 3000 m in a single lift for gold mining in South Africa.

## 2.1 Opportunities for rope improvements

Two possibilities exist for improvements in the rope strength to mass ratio for a given rope diameter:

- Lighter ropes with the same breaking strength
- Stronger ropes with the same mass per unit length

In order to investigate the effects of these factors, it is necessary to make some assumptions regarding the winding system. The two most important values in determining skip capacity for a given hoisting rope are the allowed static factor of safety and the skip factor or ratio between the empty skip mass and rock payload. For the calculations here the following values have been assumed:

$$SF = \frac{\text{Rope Breaking Strength}}{\text{Maximum Static Rope Load}} = \frac{25000}{4000 + L} \quad (1)$$

$$f_{skip} = \frac{\text{Empty Skip Mass}}{\text{Rock Payload}} = 0.7 \quad (2)$$

The static factor of safety ( $SF$ ) equation which is dependant on the maximum suspended rope length ( $L$ ) represents the latest technology for the South African mining industry, SANS (2000). The skip factor of 0.7 ( $f_{skip}$ ) is a typical value for rock skips such as are used with drum winders.

With these assumptions made, a simple equation for the rock payload ( $M_p$ ) can be determined in terms of the minimum rope breaking strength for design ( $MBL$ ), the rope mass per unit length ( $\rho$ ) and the skip factor ( $f_{skip}$ ) and maximum suspended length ( $L$ ):

$$\begin{aligned} \frac{25000}{4000 + L} &= \frac{MBL}{M_p + f_{skip} \cdot M_p + \rho \cdot L} \\ &= \frac{MBL}{M_p \cdot (1 + f_{skip}) + \rho \cdot L} \\ M_p &= \frac{MBL \cdot (4000 + L)}{25000 \cdot (1 + f_{skip})} - \frac{\rho \cdot L}{(1 + f_{skip})} \end{aligned} \quad (3)$$

For most ropes the  $MBL$  is specified in units of kN so for the payload in kg, Equation (3) would become:

$$M_p = \frac{\frac{MBL \cdot 1000}{9.81} \cdot (4000 + L)}{25000 \cdot (1 + f_{skip})} - \frac{\rho \cdot L}{(1 + f_{skip})} \quad (3a)$$

### 2.1.1 Lighter ropes with the same breaking strength

Using Equation (3a) it is possible to investigate the effects of changes in  $MBL$  and  $\rho$  on the skip payload,  $M_p$ . Starting with typical parameters for a mine hoisting rope, Figure 4 shows how skip capacity varies with depth and reduction in rope mass per unit length. Note that each line on the graph is for an assumed reduction in rope weight, thus the 0% line represents the initial conditions that would be achieved with the standard hoisting rope technology.

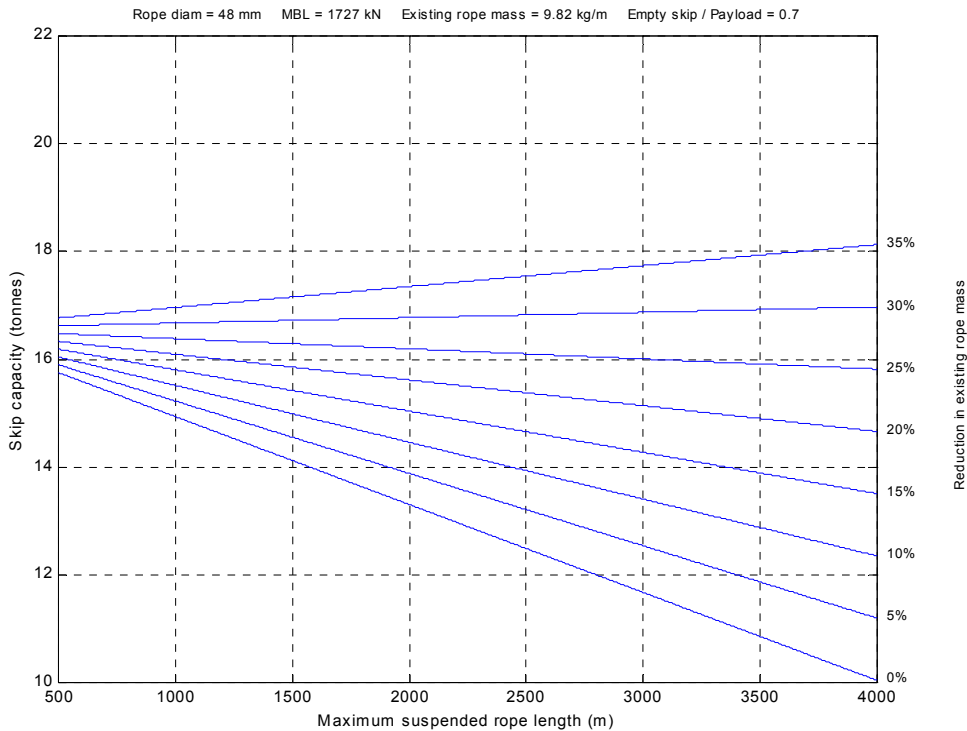

**Figure 4:** Calculated skip capacity based on typical mine hoisting system parameters for vertical shaft drum winders. The family of curves show the effect of reductions in rope mass per unit length, with maintained diameter and breaking load ( $MBL$ ), on the skip rock capacity.

Figure 4 emphasises the very real benefits to be gained by using a lightweight rope, and especially at greater depths. It is also interesting to note that because the static factor of safety decreases with depth, Equation (1), there is a unique rope strength to weight ratio which would allow for constant skip capacity at all shaft depths. Examination of Equation (3) shows that when  $MBL / \rho = 25000$  m, the skip capacity becomes independent of the suspended length ( $L$ ):

$$M_p = \frac{MBL \cdot 4000}{25000 \cdot (1 + f_{skip})} \quad (3b)$$

By comparing the skip capacities for reductions in rope mass per unit length (i.e. 5%, 10% etc.) to the standard rope technology (0%) in Figure 4, it is possible to determine the effect of the reduction in mass on the percentage increase in capacity. This gives an indication of the significance of the changes (Figure 5).

A 20% reduction in rope mass per metre at 3000 m increases the skip rock capacity by 29%. (Note that the method of calculation automatically takes into account the increase in skip mass required for the additional rock.) In service, the winder parameters would stay more or less the same since the rope diameter and line pull remains unchanged.

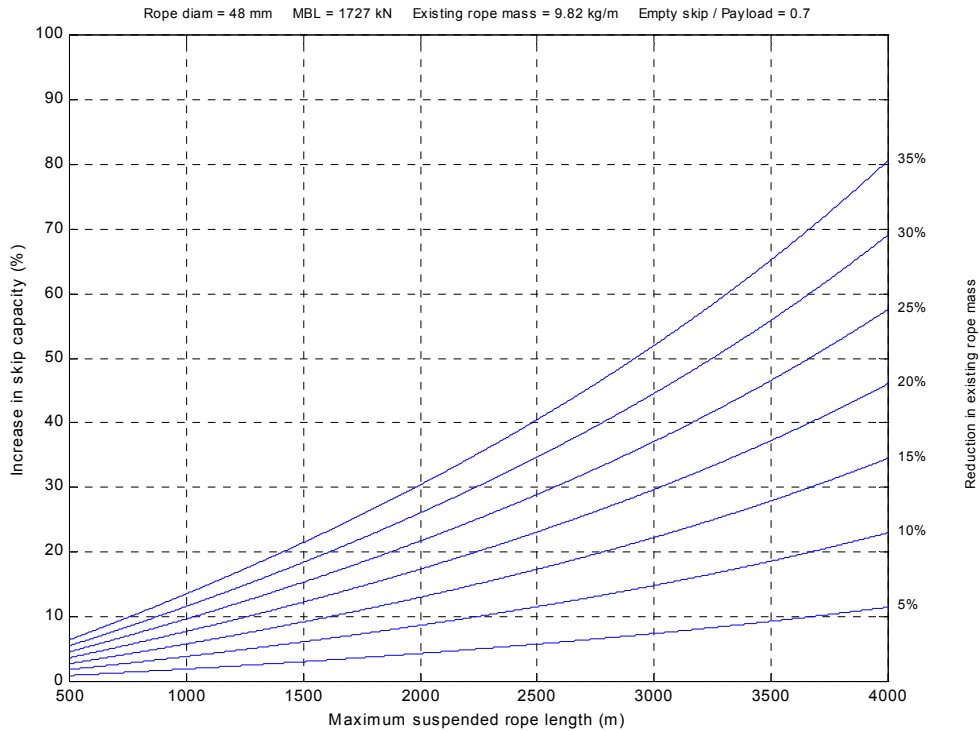
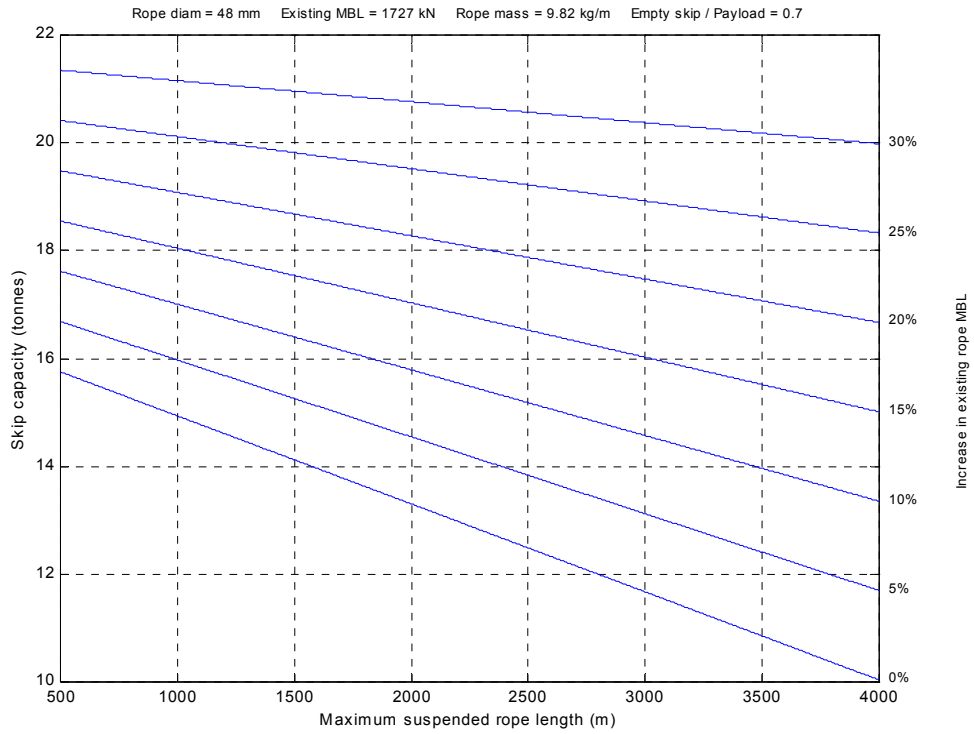

**Figure 5:** Influence of rope mass reduction on skip capacity for a typical vertical shaft drum winding installation. For these calculations it was assumed that the rope breaking strength and diameter remain unchanged.

### 2.1.2 Stronger ropes with the same mass per unit length

Figure 6 shows how skip capacity varies with depth and an increase in rope breaking strength. Note again that the 0% line represents the initial conditions achieved with standard hoisting rope technology. Although not shown in the figure, in this example an increase in strength of 39.5% would result in the capacity becoming independent of the maximum suspended length ( $L$ ), the condition discussed earlier and described by Equation (3b).

Based on the data in Figure 6, Figure 7 shows the effect on skip capacity when ropes with a higher breaking strength (same diameter and mass) are compared to the typical condition (0%).



**Figure 6:** Calculated skip capacity based on typical mine hoisting system parameters for vertical shaft drum winders. The family of curves show the effect of increases in rope breaking load (MBL) on the skip rock capacity, with maintained rope mass per unit length and diameter.

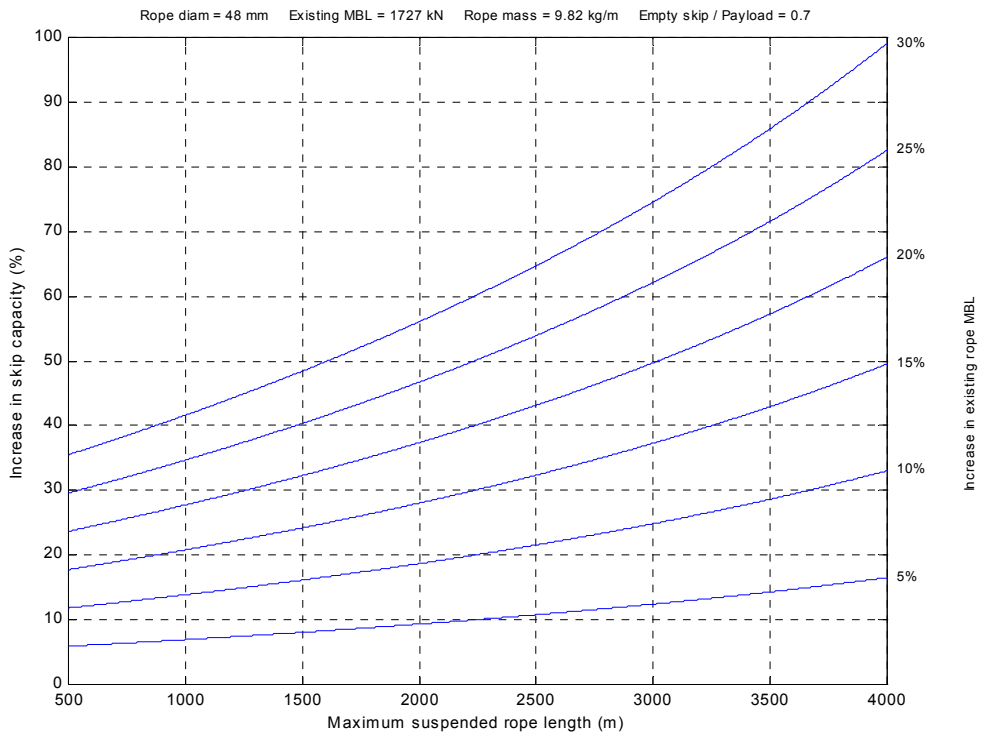

**Figure 7:** Influence of rope breaking strength increase on skip capacity for a typical vertical shaft drum winding installation. For these calculations it was assumed that the rope mass per metre and diameter remain unchanged.



In the case of a 20% increase in breaking strength, with unchanged mass per metre at 3000m, skip rock capacity increases by 50% which is significant. However, it must be borne in mind that changes to the rope breaking strength imply higher line pulls for the same static factor of safety and so the increases in capacity in Figure 7 would require changes to the design of the winding machines. For a fixed number of skips per month, shaft output and the increase in skip capacity are directly related. So, if the capacity of the skip goes up by 50% then in theory the shaft output would also increase by the same amount (assuming mining can support this).

## 2.2 Characteristic lengths – a useful comparator

For a particular rope construction, the ratio of the rope breaking strength to the mass per unit length ( $MBL / \rho$ ) is largely a constant value over the full range of typical diameters used for mining hoisting applications. This value is also the suspended length in metres where the rope would break under its own weight with no attached end load, known as the *characteristic length*. For the 1900 MPa standard mine hoisting ropes considered in the above calculations, the ratio of  $MBL / \rho$  is on average 17900 m [ $N/(N/m)$  or  $kN/9.81 \cdot 1000 / (kg/m)$ ]. For a steel rod with a tensile grade of 1900 MPa and density of  $7850 \text{ kg/m}^3$  the *characteristic length* would be 24673 m. In comparison to other Engineering materials, high strength steel wires have relatively low *characteristic lengths*. Materials like Kevlar<sup>®</sup> and Spectra 1000<sup>®</sup> show values between 200 and 315 km. When comparing these *characteristic lengths*, it is clear that there should be considerable room for improving the lifting capacity or efficiency of mining ropes. Table 1 shows how *characteristic lengths* differ for a range of materials. This is really a measure of the lifting efficiency of the materials.

| Material                        | Density (kg/m <sup>3</sup> ) | Modulus (GPa) | Tensile strength (MPa) | Characteristic length (km) |
|---------------------------------|------------------------------|---------------|------------------------|----------------------------|
| Steel wire rope                 | -                            | 120           | -                      | 19                         |
| Drawn steel wire                | 7850                         | 207           | 1960                   | 25                         |
| Carbon fibre                    | 1770                         | 300           | 3400                   | 196                        |
| Technora <sup>®</sup> fibre     | 1390                         | 73            | 3400                   | 249                        |
| Kevlar <sup>®</sup> 49 fibre    | 1440                         | 125           | 3600                   | 255                        |
| Dynema <sup>®</sup> SK75 fibre  | 970                          | 89            | 2700                   | 284                        |
| Spectra <sup>®</sup> 1000 fibre | 970                          | 113           | 3000                   | 315                        |
| Carbon nanotubes                | 1400                         | 400           | 50000                  | 3641                       |

**Table 1:** Mechanical properties of various materials (note that the values given are meant as an indication only and tend to differ from one reference to another).

## 2.3 Lighter and stronger ropes

It is also possible to consider a rope which has both a reduction in rope mass and increase in strength. Consider the combination of the previous two examples of 20% decrease in mass and a simultaneous 20% increase in strength: the skip capacity would increase by 79% at 3000 m. This implies a rope with a *characteristic length*,  $MBL / \rho$ , of 26890 m.

## 2.4 A composite rope - approximate calculations

So far we have discussed the appreciable benefits that a composite rope could have on hoisting performance compared to a steel-only rope: but given existing rope designs, can such a rope be made? Consider the example of a  $\varnothing$  48 mm *Turboplast* rope (Figure 8) which has properties as summarised in Table 2.

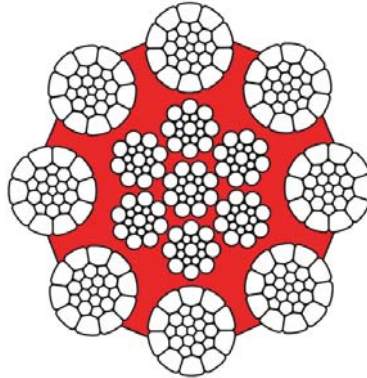

**Figure 8:** Cross-section of a *Turboplast* rope typically used on drum winders and Koepe winders up to suspended lengths of 1000 m.

| Property  |        |
|---|--------|
| Manufacturer's Breaking load MBL (kN)   | 2018   |
| Mass per unit length (kg/m)   | 10.449 |
| Nominal metallic cross-sectional area (mm <sup>2</sup> )                      | 1201.1 |
| <i>Characteristic length</i> (m)<br>(based on the MBL and the mass per metre) | 19687  |

**Table 2:** Summary of the properties of a  $\varnothing$  48 mm *Turboplast* rope, 1960 MPa grade.

Assuming a steel density of 7850 kg/m<sup>3</sup>, as an approximation, based on the metallic cross-sectional area, in each metre of rope there must be 9.429 kg of steel the remaining 1.020 kg making up the plastic layer and lubricant<sup>1</sup>.

The density of the sort of fibres which we are interested in is taken as 970 kg/m<sup>3</sup> typical modulus 113 GPa and UTS 3 GPa (e.g. Spectra<sup>®</sup> 1000, Table 1).

It is assumed that the fibre material has the same average modulus as the wires formed helically into a rope and so when these are included parallel to the axis of the rope they contribute to the share of the rope load in direct proportion to their cross-sectional area, relative to the overall load bearing area of the rope (1201.1 mm<sup>2</sup>). This assumption is from simple principles for analysing statically indeterminate structures composed of different materials. The assumption also leads to the

<sup>1</sup> Note that this calculation does not take into account the actual sectional metallic area (it assumes that all wires are "cut" perpendicular to their axis (giving a circular section), which is not the case because of their spinning or helix angle). However, this approximation is sufficiently close as to be acceptable for the purposes of this discussion.

conclusion that the nominal tensile stress in the fibres and the steel wires will be similar.

The approximate mass per metre of the composite rope would be:

$$\rho_{rope} = \frac{1201.1 \times \rho_{steel} \times (1 - r_f)}{10^6} + \frac{1201.1 \times \rho_{fibre} \times r_f}{10^6} + 1.02 \text{ (kg / m)} \quad (4)$$

where  $r_f = \frac{\text{Fibre Area}}{\text{Total Area}}$

The earlier calculations on the effects of rope mass reduction and strength increase on skip capacity showed that ropes with a *characteristic length* of between 25 km and 27 km (section 2.3) would have very significant implications for hoisting efficiency, particularly in deeper shafts. In the case of the new South African static factor of safety which decreases with an increase in suspended length  $[25000/(4000+L)]$ , it has been shown that a rope with a *characteristic length* of 25 km would be able to hoist the same payload irrespective of the depth of the shaft.

Figure 9 shows the variation in characteristic length for the 48 mm *Turboplast*. It has been assumed that the rope minimum breaking strength of 2018 kN remained unchanged by the introduction of the fibre components.

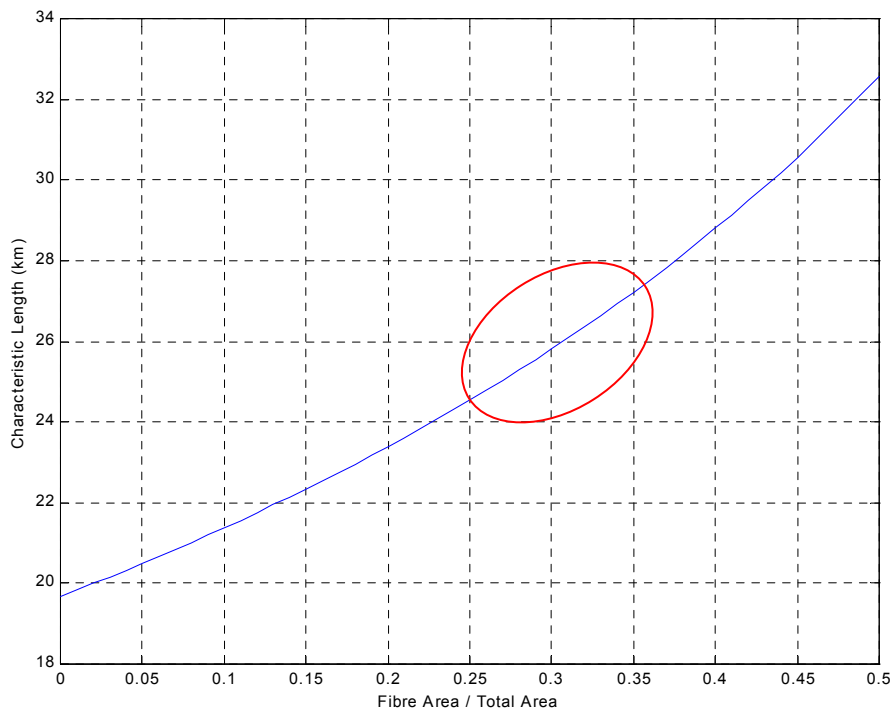

**Figure 9:** *Characteristic length* of a 48 mm *Turboplast* rope for varying amounts of high strength fibre content. The circled area shows the target *characteristic lengths* that need to be reached in order to achieve measurable improvements in shaft hoisting efficiency.

The question then arises: what possible rope configurations would produce a fibre area / total area ratio of between 0.25 and 0.35? The last column in Table 3 shows how this ratio varies for different numbers of outer strands in a typical round strand rope construction. It can be seen that ropes with between 7 and 10 outer strands would satisfy this criterion. Drum winder ropes like the *Turboplast* construction currently have 8 outer strands and so this construction is ideally suited as the starting point for a composite rope design.

| No. of outer strands | Section of outer strands compacted fill factor = 0.89<br>(mm <sup>2</sup> ) | Section of core fill factor = 0.85<br>(mm <sup>2</sup> ) | Total load bearing area<br>(mm <sup>2</sup> ) | Section of outer strands as a % of total area<br>(%) | Section of core as a % of total area<br>(%) |
|----------------------|---|--|---|--|---|
| 6                    | 43.01   | 8.63   | 51.64   | 83.3%  | 16.7%                                       |
| 7                    | 40.34   | 12.10  | 52.44   | 76.9%  | 23.1%                                       |
| 8                    | 38.30   | 15.16  | 53.46   | 71.6%  | 28.4%                                       |
| 9                    | 35.84   | 18.23  | 54.08   | 66.3%  | 33.7%                                       |
| 10                   | 33.83   | 20.94  | 54.77   | 61.8%  | 38.2%                                       |
| 11                   | 31.97   | 23.41  | 55.38   | 57.7%  | 42.3%                                       |
| 12                   | 30.28   | 25.66  | 55.94   | 54.1%  | 45.9%                                       |
| 13                   | 28.73   | 27.72  | 56.45   | 50.9%  | 49.1%                                       |
| 14                   | 27.23   | 29.65  | 56.87   | 47.9%  | 52.1%                                       |
| 15                   | 25.88   | 31.40  | 57.28   | 45.2%  | 54.8%                                       |
| 16                   | 24.63   | 33.01  | 57.64   | 42.7%  | 57.3%                                       |
| 17                   | 23.46   | 34.51  | 57.97   | 40.5%  | 59.5%                                       |
| 18                   | 22.42   | 35.87  | 58.29   | 38.5%  | 61.5%                                       |

**Table 3:** Rope strand and core load bearing areas for a 10 mm diameter rope. Note that the rope diameter is not critical here but rather the ratio between the outer strand and core areas with respect to the total cross-sectional area.

### 3 Lightweight ropes for mobile cranes

The advantages of using lightweight ropes in deep mine hoisting applications are readily appreciable. As we have just discussed, any weight which the rope does not have to support translates directly into increased payload. This benefit is still applicable to the example of a mobile crane, but there are other, less obvious benefits too.

Mobile cranes come in a wide range of lifting capacities and vary from between 5 to well over 1000 tonnes. The capacity of a crane tends to be defined as the load-moment i.e. the maximum load at a given radius, and is a measure of the crane's stability against tipping over.

In our discussion of the potential benefits to crane manufacturers of using lightweight ropes it will be helpful to calculate a practical example. Although we will consider the example of a fairly large crane, such as shown in Figure 10, it should be noted that since the strength : weight ratio for a given rope construction is fairly constant, the analysis presented here is applicable to a range of installation sizes.



**Figure 10:** Terex-Demag CC 8800 Mobile crane involved in lifting work at a chemical refinery. (Photo courtesy Hans-Peter Franzen, Terex-Demag).

As with any machine, the function of a mobile crane will influence the main design considerations. A mobile crane has the following requirements:

- It needs to be moved, and so the total weight of the load bearing structure (which includes the rope) should be as low as possible.
- It needs to be stable and as resistant to tipping over as possible.
- It needs to be able to lift a defined weight.

### **3.1 Total weight of the structure**

In a mobile crane, the total weight of the vehicle is a major factor. This is especially so for cranes such as that shown in Figure 11, which moves from one job to another by driving on the public highway. The weight of the crane must be supported by the axles which will have a specified maximum load per set. A further consideration is that in order to ensure the maximum manoeuvrability, the axle systems are sophisticated and thus expensive components of the crane. (Each pair of wheels may be operated independently, and turned so as to allow the crane to “walk” almost side-

ways, Figure 12). The crane shown in Figures 11 and 12 is a relatively small vehicle, larger cranes of this type may have up to nine such sets.

A reduced mass of rope may allow a reduction in the number of expensive axles required for a given payload. This would benefit the crane not only in terms of reduced initial construction cost, which may be significant in itself, but would also allow a shorter and more manoeuvrable vehicle.

A reduction in the total mass of the rope in the system will mean that for the same payload the counterbalance weight may be reduced. This could lead to further additional savings since it would allow a lighter weight support structure.

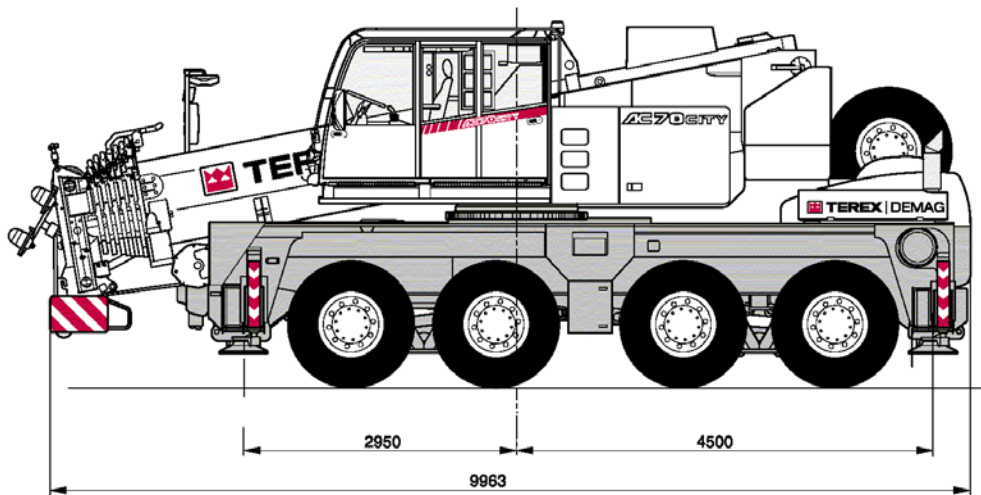

Figure 11: Example of a mobile crane, AC70 City, Terex-Demag (2005).

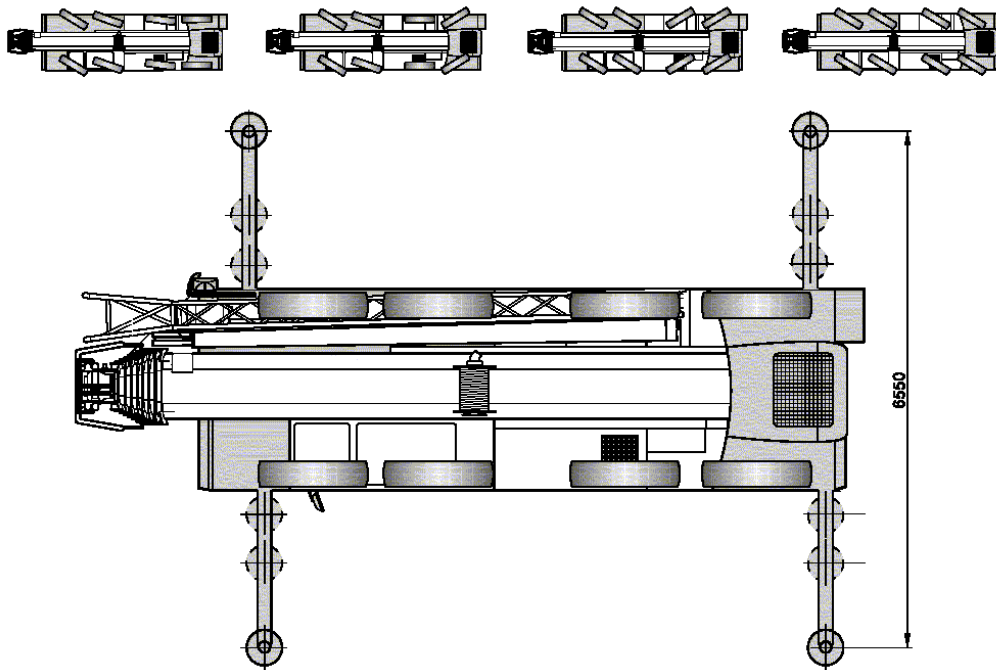

Figure 12: Plan view of an AC70 City showing independent steering axles (top) Terex-Demag (2005).

### 3.2 Stability

Consider an example of a crane lowering a load of 500 tonnes, by a height of 70 m at a radius of 22 m (Figure 13). Such a lift would require a system reeved with 2×8 falls of rope, typically  $\varnothing$  40 mm *Eurolift* (Figure 14) which weighs 7.92 kg/m.

A *Eurolift* rope has a core which comprises 57% of the rope area. From Equation (4) the mass of a  $\varnothing$  40 mm *Eurolift* with the core replaced would thus become 3.57 kg/m.

If we consider moments about the front of the caterpillar track (point A in Figure 13), as the load is lowered, the contribution to the moment from the load does not change. However, as the rope spools off the drum, out from the end of the crane jib, the mass of the suspended rope changes and therefore the moment about A. For the 70 m lift, if a conventional rope is used this corresponds to 8.9 tonnes, or if a lightweight rope 4.0 tonnes. In terms of the change in stability, this would equate to 4.9 tonnes of mass which was not moved, or a reduction in change of moment by 108 kNm.

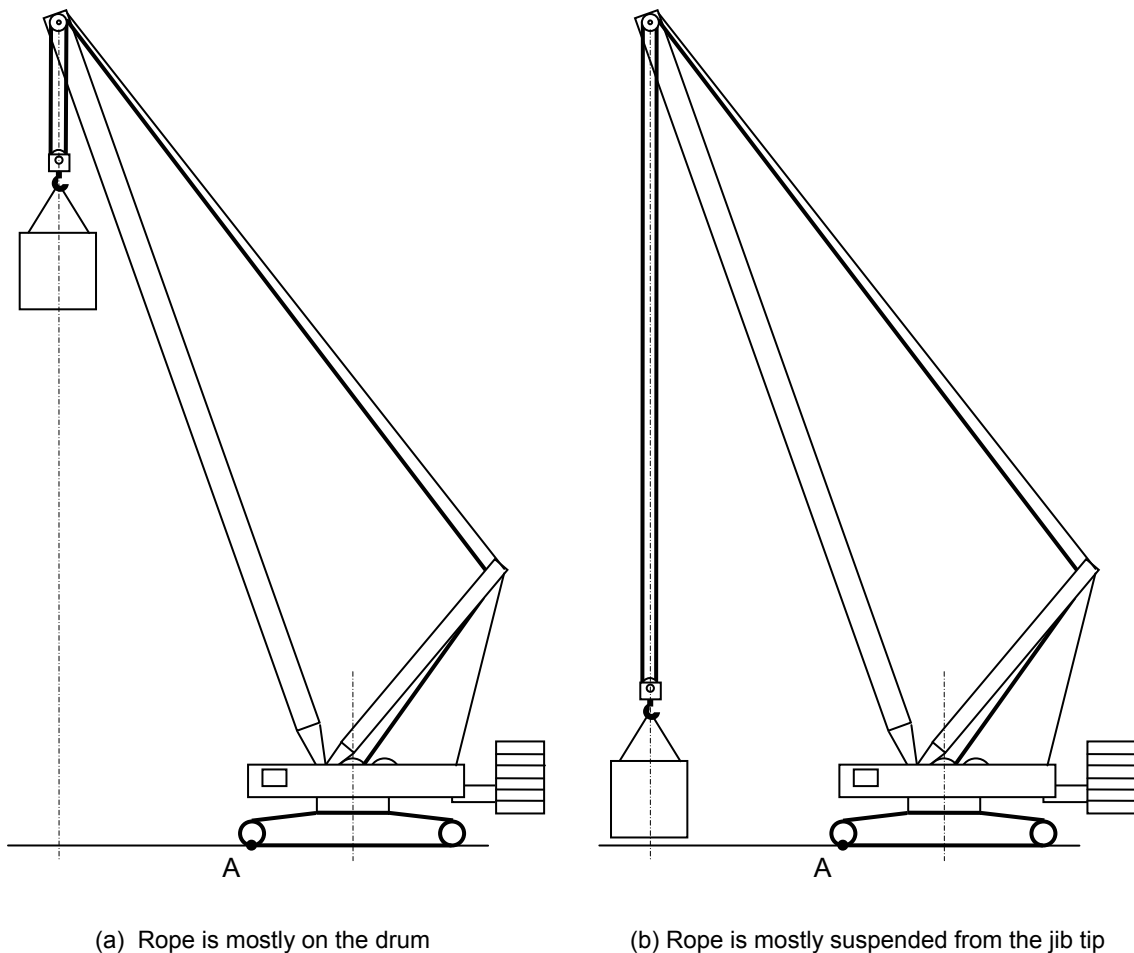

**Figure 13:** Schematic diagram showing the change in stability of the crane as the load is lowered.

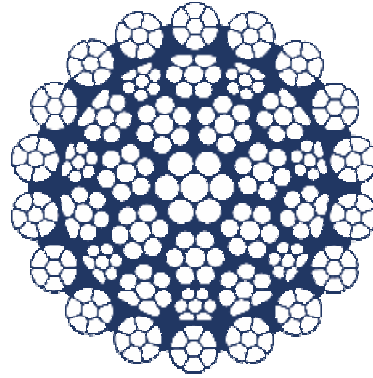

**Figure 14:** Typical crane main hoist rope (CASAR *Eurolift*).

It is noted that by replacing the core of the wire rope with fibre, that the torsional balance of the rope is likely to be affected. Cranes of this type are reeved with two ropes (and hoists) so a simple measure to avoid any problems would be to use a matched pair, one left hand the other right hand.

The example we considered showed how the movement of the hoist rope might affect the overall stability of the structure. The same arguments would apply to the other ropes in the system, such as the luffing ropes which move the boom. Here the weight of the rope is transferred from one winch to another, which will again shift the centre of gravity (and depending upon the layout of the winches may move the centre of gravity transversely (i.e. into the page in Figure 13)).

### **3.3 Increased payload**

Benefits from lightweight ropes may also be found if the rope is used on existing cranes. If the lightweight rope is not only as strong as the rope it is replacing, but stronger, it be possible to increase the payload provided the framework can support the additional load.

Another option would be to lift the same mass but to reduce the number of falls in the reeving. This would mean that the work could be done more quickly, as there was less rope to spool in or out. Further, this would mean that even less mass was moved when raising or lowering the load, which as we have seen in Section 3.2 has a beneficial effect on the stability of the system.

### **3.4 Other considerations**

There are a number of other potential benefits which may be considered:

- A wire rope with a fibre core would have a lower bending stiffness than a conventional rope with steel core. This would lead to a more efficient rope, which could in turn lead to lower hook block weight requirements.
- A lighter rope would also have benefits for the winch design, where the lower inertia of the system could lead to reduced power requirements.
- A lighter, more flexible rope would be easier for riggers to handle when reeving of the blocks.



Although some of the benefits discussed above may seem fairly minor, when taken as a whole in terms of the efficiency, weight and cost savings, the use of lightweight ropes in mobile cranes could be a very serious consideration.

## 4 Lightweight ropes for offshore applications

### 4.1 Mooring lines

The advantages of using lightweight ropes in offshore applications have long been recognised (Del Vecchio, 1992). In fact, in the deep water mooring application, there is a depth at which fibre ropes become the only viable option for a mooring, since the weight of the conventionally used wire rope or chain means that the sag of the catenary cannot provide effective station-keeping.

Since fibre ropes are near neutrally buoyant, their strength may be fully employed for station keeping rather than divided between this and supporting the suspended (self) weight of the rope below.

Fibre ropes, although as strong as or stronger than wire ropes are very easily damaged. Care should be taken when handling them not to introduce compressive buckling loads into the fibres, they are very sensitive to transverse (compressive) loading and vulnerable to damage from abrasion. In the case of offshore moorings, in order to avoid these problems the fibre rope tends to be used for the main length of the line, but connected between much more rugged wire ropes or chains (Figure 16).

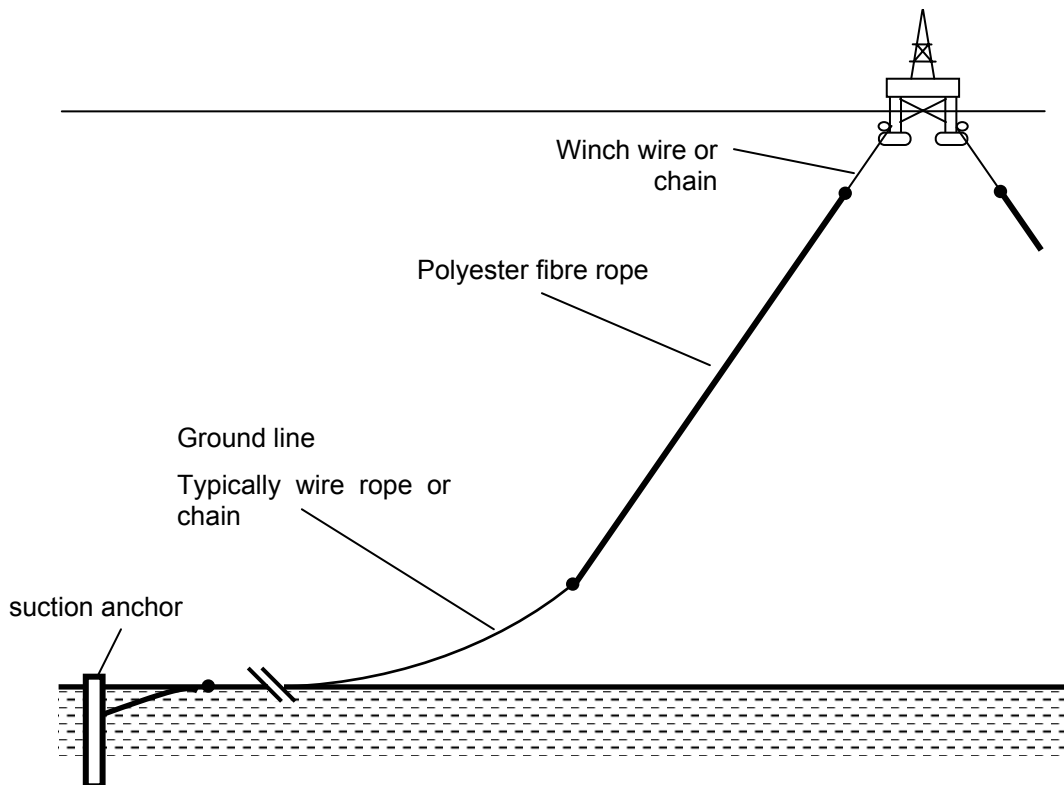

Figure 16: Schematic drawing of a "taut" mooring line comprising wire and fibre components.

With the oil industry seeking to re-use existing facilities in deeper water it is advantageous to use the conventional wire rope or chain at the top end of the line. (Note we will use the term wire rope from hereon, but the comments also apply to chain.) This will remove the costly need to change the winch system (on which service of fibre ropes is unproven). At the bottom of the line, where the mooring interacts with the sea bed, it is necessary to employ the much more rugged wire rope in order to protect the fibre rope from abrasion damage and particle ingress.

However, there are disadvantages to this system.

- Care must be taken to avoid potentially damaging cyclic twisting oscillations in the system if torsionally mismatched elements (such as a six strand wire rope and parallel strand fibre rope) are employed (Chaplin *et al.*, 2000).
- Consideration needs to be given to the length of fibre and wire rope in the system. Fibre rope (especially polyester fibre rope) is subject to significant creep when first installed. Thus care should be taken that there is sufficient wire rope in the top of the system to be able to remove this elongation and set the required tension in the line without pulling the connection into the fairlead pulley. (The fairlead pulley is at the bottom of the platform leg just above the pontoon.)
- The combination line configuration is not very suitable for more mobile rigs, such as drilling rigs which are on location for a limited period (a few months to a year). Ideally at each rig move, the whole mooring line would be winched in and the rig towed to a new site. However, if there are bulky connectors along the line, these have to be disconnected and recovered in expensive time consuming offshore operations. Frequent handling also increases the chances of damage.

The solution to these problems is a lightweight rope which combines the ruggedness of a wire rope with the lightness of a fibre rope and could thus allow the use of mooring lines made up of a single element. Table 4 and Figure 17 show how the mass of the composite rope drops as the number of outer strands and consequently the relative volume of the fibre core increases. (Note that these calculations are subject to the same approximation described in Section 2.4.)

| No. of outer strands | Volume of whole rope over 1 m length | Mass in air of steel only rope | Mass in sea water of steel only rope | Mass in air of composite rope | Mass in sea water of composite rope | Mass in sea water of composite rope |
|----------------------|--------------------------------------|--------------------------------|--------------------------------------|-------------------------------|-------------------------------------|-------------------------------------|
| -                    | (m <sup>3</sup> )                    | (kg/m)                         | (kg/m)                               | (kg/m)                        | (kg/m)                              | (% of steel rope in sea water)      |
| 6                    | 5.16E-05                             | 0.405                          | 0.352                                | 0.346                         | 0.293                               | 83.1                                |
| 7                    | 5.24E-05                             | 0.412                          | 0.358                                | 0.328                         | 0.274                               | 76.7                                |
| 8                    | 5.35E-05                             | 0.420                          | 0.365                                | 0.315                         | 0.260                               | 71.4                                |
| 9                    | 5.41E-05                             | 0.425                          | 0.369                                | 0.299                         | 0.243                               | 66.0                                |
| 10                   | 5.48E-05                             | 0.430                          | 0.374                                | 0.286                         | 0.229                               | 61.4                                |
| 11                   | 5.54E-05                             | 0.435                          | 0.378                                | 0.274                         | 0.217                               | 57.4                                |
| 12                   | 5.59E-05                             | 0.439                          | 0.382                                | 0.263                         | 0.205                               | 53.7                                |
| 13                   | 5.64E-05                             | 0.443                          | 0.385                                | 0.252                         | 0.194                               | 50.5                                |
| 14                   | 5.69E-05                             | 0.446                          | 0.388                                | 0.242                         | 0.184                               | 47.4                                |
| 15                   | 5.73E-05                             | 0.450                          | 0.391                                | 0.234                         | 0.175                               | 44.7                                |
| 16                   | 5.76E-05                             | 0.452                          | 0.393                                | 0.225                         | 0.166                               | 42.2                                |
| 17                   | 5.80E-05                             | 0.455                          | 0.395                                | 0.218                         | 0.158                               | 39.9                                |
| 18                   | 5.83E-05                             | 0.458                          | 0.398                                | 0.211                         | 0.151                               | 37.9                                |

**Table 4:** Benefit in terms of reduced mass (% of an all steel rope in sea water) of a composite rope.

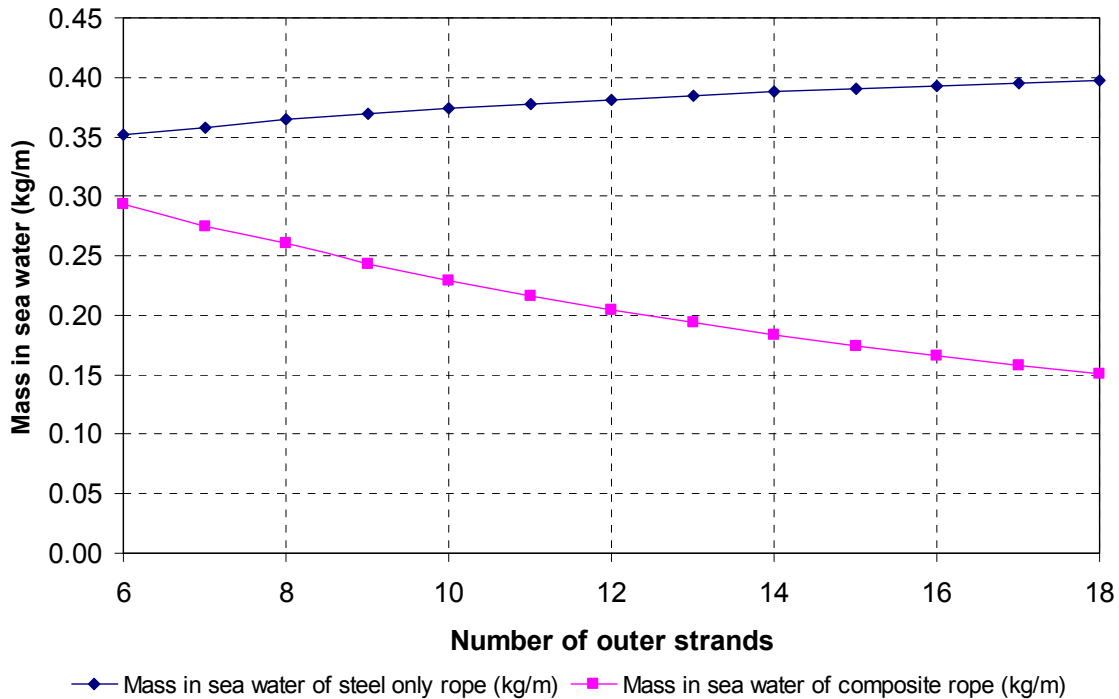

**Figure 17:** Comparison of the mass in seawater of steel only and steel-fibre ropes as a function of number of outer strands.

From Figure 17 it may be seen that for a composite rope with 18 outer strands there is a significant advantage over the all wire rope. (Note that a neutrally buoyant rope would lie on the x-axis.) Thus whilst a composite rope might not have quite the same station keeping properties of the wire rope and polyester line, there would be significant benefits in terms of ease of deployment and ruggedness. The internal fibre core could be protected from marine ingress by a semi-permeable membrane and/or a plastic covering.

#### 4.2 Deepwater installation of hardware

With the operation of platforms at greater water depths, there is an attendant requirement for the installation of large hardware “packages” sub sea. The DISH JIP programme (Deepwater Installation of Subsea Hardware) has been set up with the aim to meet the needs of industry to be able to lower units of 250 tonnes to depths greater than 2,000 m (Standing, 2004).

The DISH project has identified fibre ropes as the solution to the problem of the self weight limitations of wire ropes. Such ropes also have the advantage that it is relatively straightforward to make them torque balanced, unlike a composite fibre rope where this would still be possible, but would require careful design to achieve it.

However, issues still remain, the major consideration being the operation of a fibre rope on the conventionally used vessel equipment such as heave motion compensators and especially traction winches. The operation of ropes on such

hardware requires a good bending fatigue characteristic, and good resistance to wear.

With reference to the operation of a fibre rope on a traction winch, a further problem is the issue of the value of the coefficient of friction (both wet and dry) between the rope and the sheaves. If this value is too low the winch will not operate correctly and the rope will slip and wear. It is not unreasonable to assume that the co-efficient of friction of a composite lightweight rope with outer steel strands would have coefficient of friction values the same as the conventionally used and already proven steel wire rope.

Careful consideration still needs to be given to other factors such as axial damping, resonance effects and snap or shock loading, as with the fibre rope. However, the lightweight composite rope does seem to provide a solution to the major problems of a fibre only solution.

## 5 Non-destructive testing issues

A key factor in the design and operation of composite mining ropes will be the safe and reliable non-destructive testing (NDT) of these. Magnetic inspection techniques are normally applied to the NDT of steel wire ropes and these have been established as an accurate means of condition assessment of wire ropes over many years. If the rope structure would incorporate non-metallic load bearing members, like the high strength aramid and high modulus polyethylene fibres, then an immediate question from operators will be how to detect deterioration of the fibre core. How important load bearing fibre core condition monitoring is in practice will depend on the proportion of the total rope area that it represents. Table 3 showed that for an 8 strand rope the core would be circa 28.4% of the total area where a 12 strand rope would have a core area representing close to 46% of the total. Clearly the significance of core integrity in these two examples would be different.

An approach to addressing the core condition monitoring would be to demonstrate, through extensive laboratory and field trials, that the fibres always outlast the steel wires in bending and tension fatigue conditions (i.e. when formed into composite ropes) as well as under conditions of multilayer coiling on drums. It is well-known that the fatigue properties of high strength aramid and polyethylene fibres far exceed those of steel wires. It is therefore not unreasonable to expect that in a properly designed composite rope the fibre core could significantly outlast the outer steel wires under all operating conditions. The design of steel strands for deep shaft winding applications is at a relatively advanced stage and these could be used also for the composite rope (e.g. the *Turboplast* outer strands). The challenge would be to design a jacketed fibre core that addressed issues such as inter-fibre fretting and transverse loading that could lead to core deterioration. CASAR is developing a number of different fibre core designs to address these problems.

It is highly likely that operators would still require independent verification of core integrity in spite of the fact that it may always outlast the steel outer strands. Rebel *et al.* (2000) gave a detailed analysis of various condition monitoring techniques for fibre mooring ropes used in offshore applications (where magnetic techniques can not be applied). Different approaches to condition monitoring were listed including:

- Vibrational techniques

- Magnetic resonance
- Conductive internal elements
- Fibre optics, including:
  - Mach-Zehnder interferometers;
  - Sagnac / Michelson interferometers;
  - Fabry-Perot interferometers;
  - intensity based sensors;
  - speckle pattern sensors;
  - Brillouin scattering;
- intra-core Bragg reflection grating sensors.

Of the methods of non-destructively monitoring fibre ropes the use of fibre optic systems appeared to be the most feasible and there are already specific examples of ongoing development of this technology for fibre ropes and steel strands. The proposed fibre optic techniques rely primarily on the application of distributed strain sensor systems which are already being used successfully in other "smart" materials and structures. In the case of ropes, and particularly fibre ropes, relatively high operating strains prevent simple insertion of the monitoring fibres into the structure and so strain attenuation schemes need careful consideration. Figure 18 shows an example of the integration of a fibre optic sensor element into a parallel lay fibre rope.

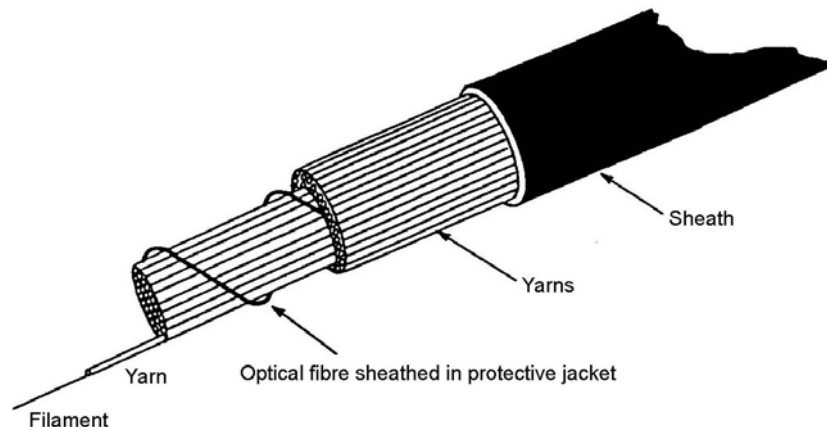

**Figure 18:** Structure of a parallel lay fibre rope with an embedded optical fibre sensor, from Robertson and Ludden (1997).

## 6 Conclusions

The analysis in this paper has shown that lightweight ropes have considerable potential in hoisting applications. Composite mining ropes can significantly enhance the performance of deep shaft systems by allowing for notable reductions in rope mass per metre while maintaining rope diameter and breaking strength. For future deep shafts the implications of changing to composite ropes are so dramatic that their use could change the economics of a shaft hoisting system. This could take new development projects from not feasible to feasible allowing greater flexibility to mining companies in their investment decision making. The application of composite ropes in existing shafts could allow greater payloads to be hoisted with the same winding

plant. For rock winders this would lead to increases in shaft output and greater returns on existing capital investment.

For service in mobile cranes, lightweight ropes could lead to improved stability, reduction in total weight (and cost) of the vehicle; and, increased efficiency leading to further reductions in operating costs. Offshore there are opportunities for composite mooring lines, especially for drilling rigs and for ropes for operation on traction winches in deepwater operations.

## 7 References

- Chaplin, C.R., Rebel, G. and Ridge, I.M.L. (2000) *Tension-torsion interactions in multi-component mooring lines*, paper no. OTC 12173, Proc. 33rd Annual Offshore Technology Conference Houston Texas, May 2000.
- Del Vecchio, C.J.M. (1992) *Lightweight materials for deep water moorings* PhD thesis, Department of Engineering, The University of Reading, June 1992.
- Dolan, T.G. (2003) *Carbon fibres for the wire rope industry?*, Wire Rope News & Sling Technology, 25, (2), pp 8,11-13.
- Klees, D.A., Hoganson, R.B. and Data, H.L., (AMSTED Industries Incorporated), (1989) *Rope with fibre core and method of forming same*, US Patent 4887422.
- McKenna, H.A., Hearle, J.W.S. and O'Hear, N. (2004) *Handbook of Fibre Rope Technology*, 416 pp, ISBN: 0849325889 (CRC Press, USA).
- McKenzie, I.D. (Haggie Rand Limited), (1990) *Reduced mass rope*, South African Provisional Patent Application No. 89/8857.
- Olsen, E.G, O'Donnell, H.J. (Otis Elevator Company), (1999) *Apparatus to inspect hoisting ropes*, US Patent 5890564.
- Rebel, G. (1997) *The torsional behaviour of triangular strand steel wire ropes for drum winders*, PhD Thesis, University of the Witwatersrand, South Africa, 328 p.
- Rebel, G., Chaplin, C.R., Groves-Kirkby, C., and Ridge, I.M.L. (2000) *Condition monitoring techniques for fibre mooring ropes*, Insight - Journal of the British Institute of Non-Destructive Testing, Vol. 42, No. 6.
- Robertson, P.A, Ludden, B.P., (1997) *A fibre optic distributed sensor system for condition monitoring of synthetic ropes*, IEE Colloquium (Digest) No. 033 1997, pp 12/1-12/6.
- SANS (2000) SANS 10294 Edition 1 : *The performance, operation, testing and maintenance of drum winders relating to rope safety*, South African National Standards, Pretoria, 2000, ISBN 0-626-12600-2, pp. 1-43. Rope factor of safety equation included from Regulation 16.34.2 of the South African Mine Health and Safety Act, 1996 (Act 29 of 1996).
- Standing, R.G. (2004) *Deepwater Installation of Subsea Hardware (DISH) phase 3*, Proposal No. Q/84123 Rel. 2, BMT Fluid Mechanics Ltd. 2004.
- Terex-Demag (2005) *AC70 City: All terrain crane*, Technical Sales Catalogue, pub. Terex-Demag, Zweibrücken, Germany, August 2005.